

KÓD

RZ09S

NÁZEV PRODUKTU

Rozdělovač s regulačními, termost. a mech. ventily 9 okruhů

OBRÁZEK

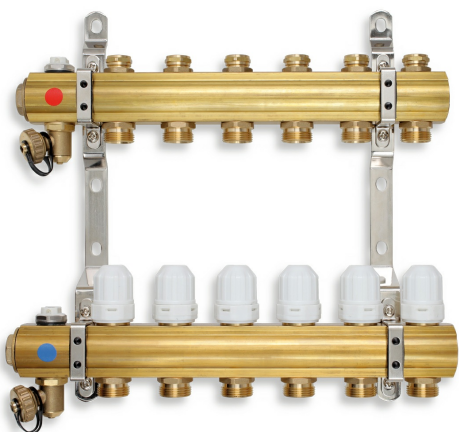

PIKTOGRAM



VLASTNOSTI PRODUKTU

- Provedení: 9 okruhů
- Hloubka krabice [mm] : 540
- Výška krabice [mm] : 388
- Typ : s termostatickými ventily
- Šířka krabice [mm] : 100
- Záruka [rok] : 15

TECHNICKÝ VÝKRES

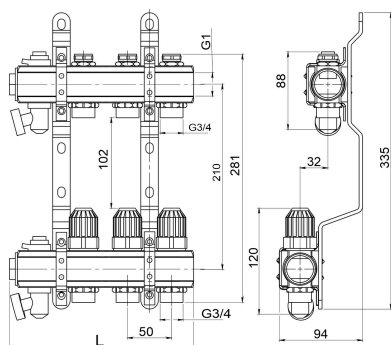

SPECIFIKACE

- EAN: 5901095680540
- Intrastat: 74122000
- Hmotnost brutto [kg]: 8